

# **Epson 25 Phase 2 Mid-Range Business Plan (FY2019-FY2021)**

March 14, 2019  
Seiko Epson Corporation

## ■ Disclaimer regarding forward-looking statements

---

The foregoing statements regarding future results reflect the Company's expectations based on information available at the time of announcement. The information contains certain forward-looking statements that are subject to known and unknown risks and uncertainties that could cause actual results to differ materially from those expressed or implied by such statements.

Such risks and uncertainties include, but are not limited to, the competitive environment, market trends, general economic conditions, technological changes, exchange rate fluctuations and our ability to continue to timely introduce new products and services.

## ■ Note regarding business profit

---

Business profit is calculated by deducting cost of sales and SGA expenses from revenue.

Although not defined in the statement of consolidated comprehensive income, this indicator is very similar to the concept of operating income under J-GAAP. Epson will present this information as a reference, as the Company believes users of financial statements will find it useful when evaluating Epson's financial performance.

## ■ Numerical values presented herein

---

Numbers are rounded down to the unit indicated. Percentages are rounded off to one decimal place.

Years mentioned in these materials are fiscal years unless otherwise indicated.

We at Epson are creating new value with aspirations of creating a better world and becoming an indispensable company.



Dry-process office papermaking system



High-speed linehead inkjet multifunction printer

# Contents

1. Goals of Epson 25 Corporate Vision
2. Epson 25 Phase 1 Mid-Range Business Plan Review
3. Epson 25 Phase 2 Mid-Range Business Plan
4. Financial Targets
5. Shareholder Returns



1. **Goals of Epson 25 Corporate Vision**
2. Epson 25 Phase 1 Mid-Range Business Plan Review
3. Epson 25 Phase 2 Mid-Range Business Plan
4. Financial Targets
5. Shareholder Returns



Creating a new connected age of people, things and Information with efficient, compact and precision technologies

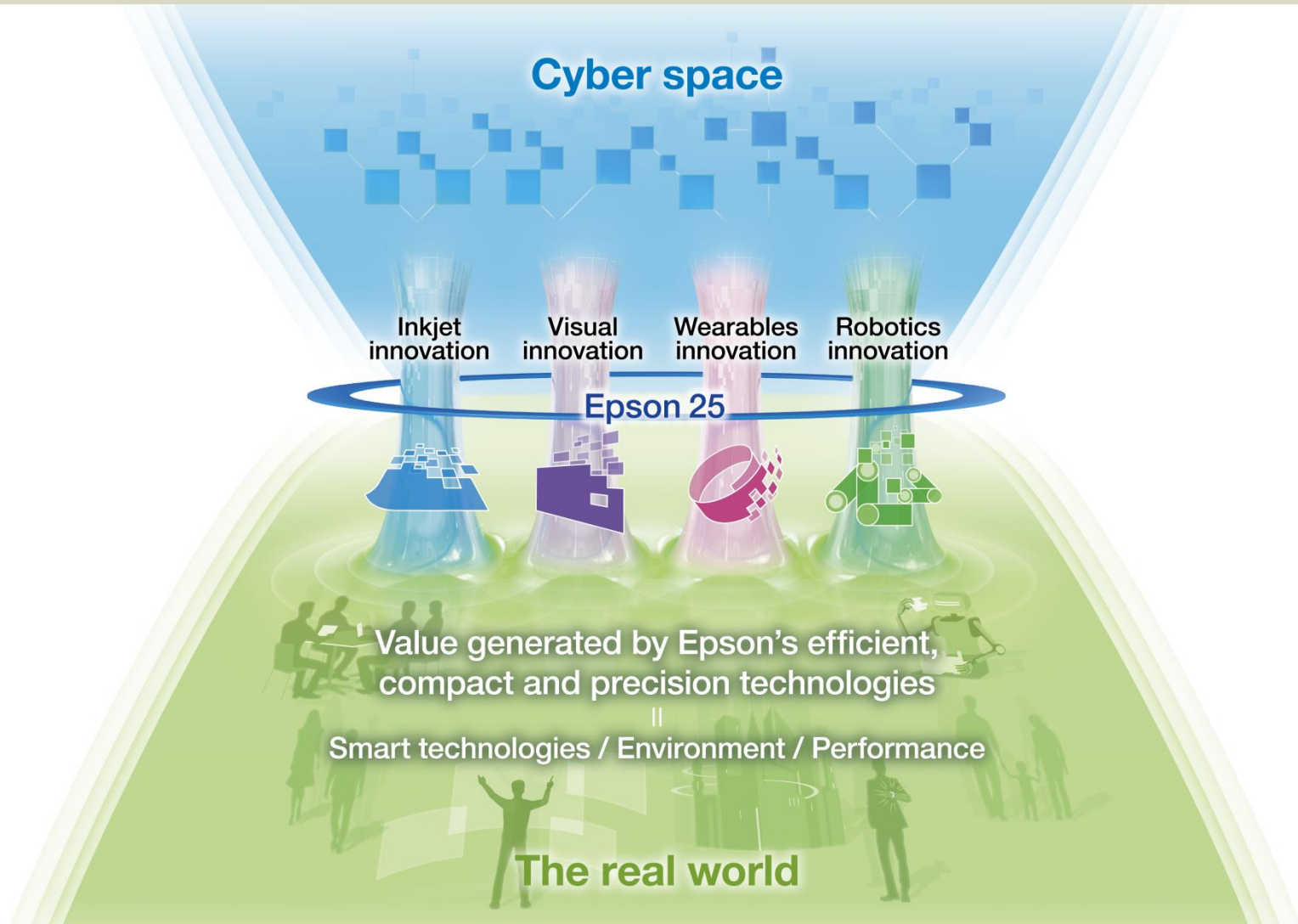

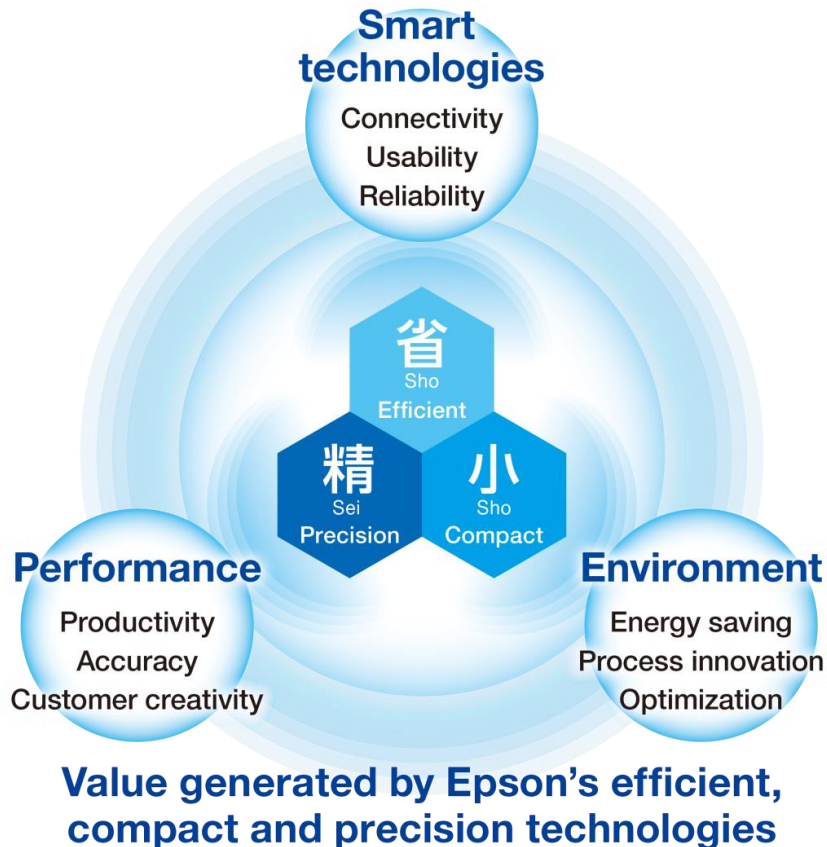

## Smart technologies

Create convenient and easy-to-use products that can be used anytime and anywhere, and which help customers reduce waste, and save effort, time and money

## Environment

Leverage Epson products to reduce environmental impact by improving customers' work processes, and contribute to a sustainable society

## Performance

Use outstanding products to contribute to customers' performance through productivity, accuracy and creativity.



## **Inkjet innovation**

Refine Micro Piezo technology, and expand into high-productivity segments. Improve environmental performance and create a sustainable printing ecosystem.



## **Visual innovation**

Refine original microdisplay and projection technologies, and create outstanding visual experiences and a natural visual communications environment for every aspect of business and lifestyles.



## **Wearables innovation**

Leverage our watchmaking heritage, refine leading technology, and offer a sense of status and fashion



## **Robotics innovation**

Combine our core technologies with sensing and smart technologies in manufacturing, expand applications, and create a future in which robots support people in a wide variety of situations.



# Direction of Growth

- Greatly expand business in the office and industrial domains by 2025.
- Create platforms to drive expansion in commercial and industrial domains.

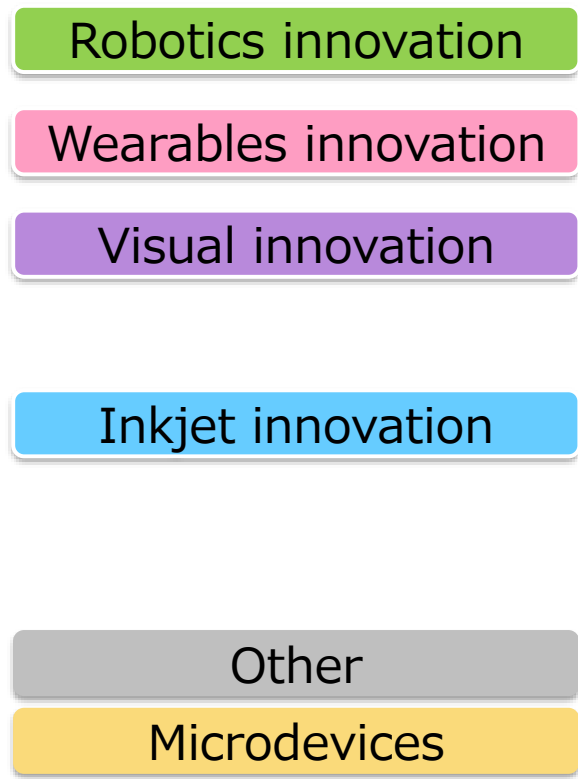
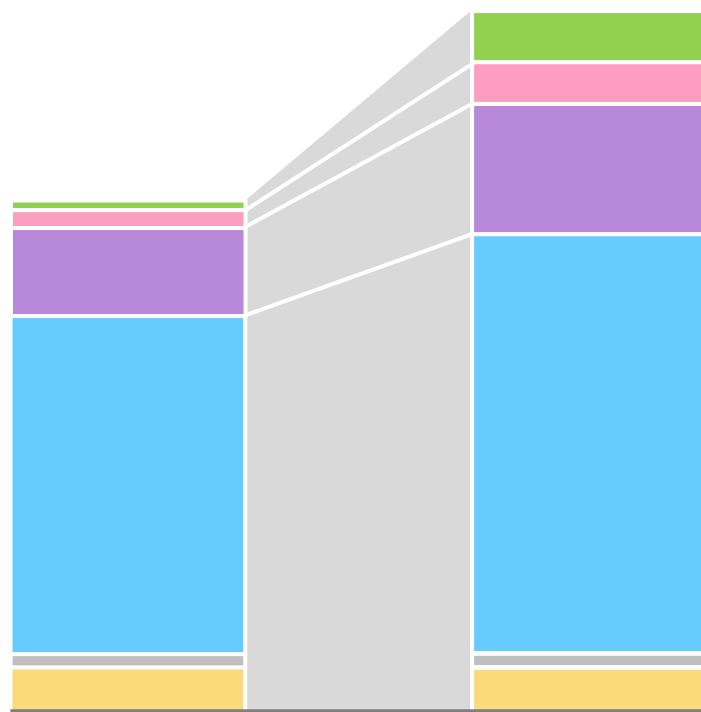

	2015 actual	2025 target
Revenue	¥1,051 billion	¥1,700 billion
Business profit	¥76.3 billion	¥200 billion
ROE	9.5%	15%

1. Goals of Epson 25 Corporate Vision
- 2. Epson 25 Phase 1 Mid-Range Business Plan Review**
3. Epson 25 Phase 2 Mid-Range Business Plan
4. Financial Targets
5. Shareholder Returns



## Underachieved on Phase 1 revenue and ROS targets

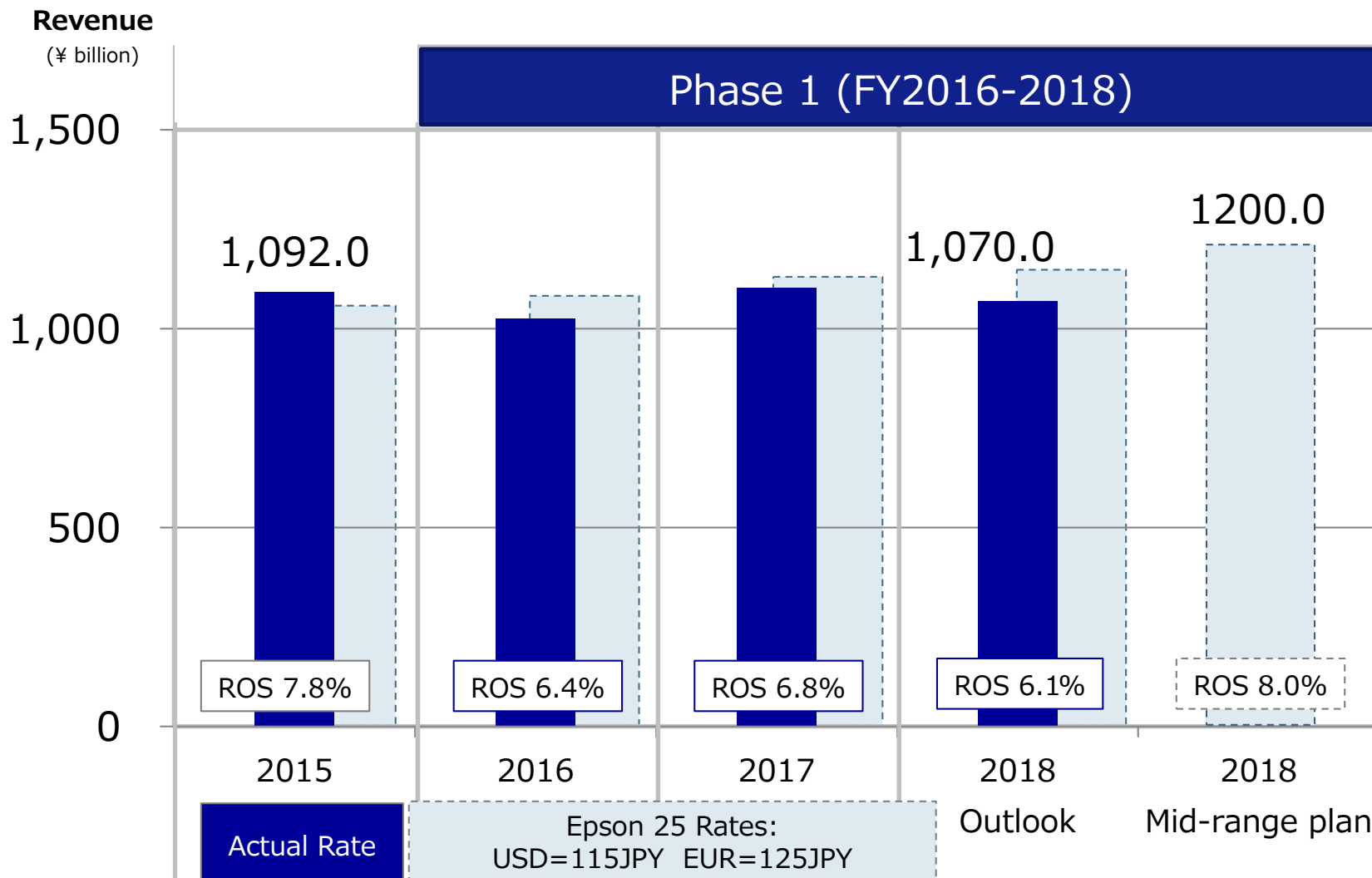

## Executed necessary investments toward achieving Epson 25, but FCF fell short of plan due to underachievement in revenue and profit.

Item	Phase 1 Target	Outlook*	Difference
Operating CF	¥330.0 billion	¥274.1 billion	¥-55.8 billion
Investment CF	¥-210.0 billion	¥-229.4 billion	¥-19.4 billion
FCF	¥120.0 billion	¥44.7 billion	¥-75.2 billion
R&D	Aggressive investment	¥158.0 billion	-
Capital expenditure	¥210.0 billion	¥237.7 billion	¥+27.7 billion

\*FY2016 & FY2017: Actual, FY2018: Outlook

## Investments to acquire future technology

- Jun. 2016 Made textile printer manufacturer **Robustelli** a wholly-owned subsidiary
- Jun. 2018 Made **Shinko Sellbic** a wholly-owned subsidiary to acquire compact injection molding technology
- Feb. 2019 Forged capital ties with AI venture company **Cross Compass**

## Preparations for growth progressed to varying degrees and have not connected to earnings

Phase 1 Basic Policies	Accomplishments	Issues
<p><b>Establish a path to growth</b></p> <ul style="list-style-type: none"> <li>• Reinforce competitive advantages</li> <li>• Business transformation and new market advancement</li> </ul>	<ul style="list-style-type: none"> <li>• Shifted from I/C printers to high-capacity ink tank printers in emerging markets</li> <li>• Strengthened core technologies</li> <li>• Increased production capacity</li> </ul>	<ul style="list-style-type: none"> <li>• Shifting the business model from LPs to high-capacity ink tank printers</li> <li>• Responding to rapid digitization</li> <li>• Creating new markets</li> </ul>
<p><b>Increase customer value with smart technologies, environmental benefits, and performance</b></p> <ul style="list-style-type: none"> <li>• Creation of products &amp; services</li> </ul>	<ul style="list-style-type: none"> <li>• Launched strategic products (LIJ, laser projectors)</li> <li>• Expanded product line-ups (high-capacity ink printers &amp; high-lumen projectors)</li> <li>• Accumulated customer insights</li> </ul>	<ul style="list-style-type: none"> <li>• On-time product launches</li> <li>• Offering functions and services that meet customer needs</li> </ul>
<p><b>Enhance sales structure</b></p> <ul style="list-style-type: none"> <li>• Quickly establish new business models</li> </ul>	<ul style="list-style-type: none"> <li>• Strengthened B2B sales organization (Japan &amp; Western Europe)</li> <li>• Enhanced billing plans (Japan &amp; Western Europe)</li> </ul>	<ul style="list-style-type: none"> <li>• Establishing sales proposal techniques for B2B</li> <li>• Establishing B2B sales structure in North America, etc.</li> <li>• Expanding billing plans (other regions)</li> </ul>
<p><b>Steadily invest in management resources as needed</b></p>	<ul style="list-style-type: none"> <li>• Invested aggressively in capex for growth</li> <li>• Invested aggressively on R&amp;D</li> <li>• Invested in companies to acquire future technology</li> </ul>	<ul style="list-style-type: none"> <li>• Strengthening sales in Middle East, Africa, etc.</li> <li>• Determining investment and expenditure priorities</li> </ul>

## **Rapid advances in digitization**

- New businesses emerged and customer touch points changed
  - Inkjets drove digitization of commercial and industrial printing
  - Advances in robotization and IoT
- .....

## **Greater expectations for corporate sustainability**

- Tougher environmental regulations requiring improved environmental performance and reduced waste
- .....

## **Uncertainty increased due to political and economic changes**

- Emerging markets continued to grow, but the Chinese economy slowed while Latin America and other regions saw currency devaluations and ongoing economic stagnation
- Uncertainty increased over the medium and long terms

## High-capacity Ink Tank / Home & SOHO/ Office Shared Printers

### Put office market development on track with inkjets

- Captured growth while shifting away from IJP and LP business model (cartridge business model) that depends on sales of consumables
  - Sales of high-capacity ink tank printers grew substantially in emerging markets
  - Started full-fledged sales in developed markets
- 
- Replacement of LPs did not go as expected

High-capacity ink tank printer cumulative global unit shipments topped 30 million



### Epson's inkjet printer unit sales

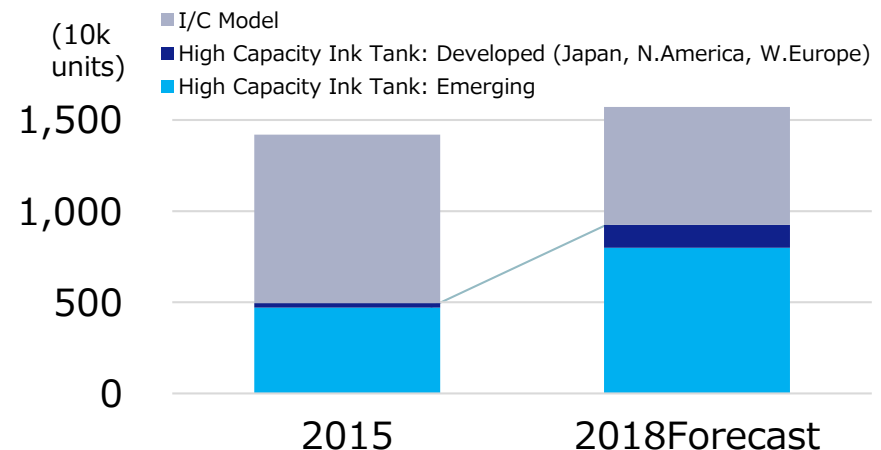

## Office Shared Printers

### Put office market development on track with inkjets

- Launched high-speed linehead inkjet multifunction printers
  - Strengthened sales organizations in Japan and Western Europe
  - Understood customer needs from launched products
- 
- Unable to adequately communicate the benefits of inkjets
  - Late in providing functions and services that meet customer needs
  - Late in building sales organizations outside Japan and Western Europe





## Commercial and Industrial Printers

### Accelerate the switch from analog to digital

- **Made progress in developing platforms and products for future growth**
  - **Increased PrecisionCore printhead production capacity**
- 
- Saw some growth in new areas (signage, textiles and labels), but growth was limited by delayed product launches
  - Markets expanded faster than expected due to the rapid advance of digitization, but we were unable to fully respond to diversified needs

Signage



Textiles



Labels



Printheads



## Projectors

### Increase market presence with laser projectors

- Continued to expand market share with strong products and services despite a contraction of the existing projector market due to FPDs
  - Increased our market presence by launching high-brightness laser projectors
- 
- New markets for small projectors expanded



High-brightness laser projector

FY17  
No. 1 Global  
Share\*

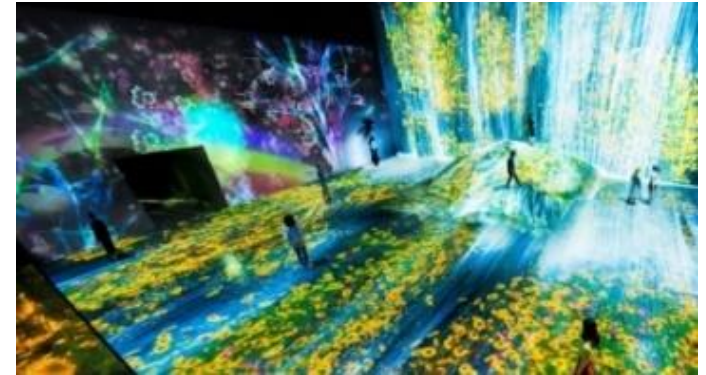

Sponsored the Epson TeamLab Borderless digital art museum as a projection partner

\* Based on unit shipments of projectors of 500 lumens or more, per Futuresource Consulting Limited

## Create new markets by proposing new applications

### Digital Lighting

- Launched accent lighting projectors for the spatial design market



### Smart Glasses

- Launched new products with silicon OLEDs

---

- Didn't achieve substantial growth



## Watches

**Strengthen the foundation of the watch business and introduce distinctive new families of products that integrate sensor technologies**

- Focused resources on the high-value-added analog watch segment to capitalize on Epson's unique technology
  - Launched original Trume brand
- 
- Sales of sports watches did not meet expectations

Epson original brands



**TRUME**

  
**ORIENT STAR**

Movement



Seiko Business



(Sold by Seiko Watch Corp.)

## Robots

**Drive manufacturing innovations by providing robots that meet a wide range of automation needs and solutions that accomplish sophisticated tasks**

- Sales grew smoothly as the market expanded and Epson launched strategic products
- Transferred sensing and software technology assets refined by the wearable products business to the robotics solutions business
- Forged capital ties with AI venture company Cross Compass



SCARA robots with integrated controllers (T series)



Compact 6-axis robots (N series)



Force sensors  
Gyro-sensors

Create a foundation to achieve the corporate vision by strengthening core technologies for key products



- PrecisionCore
- Color Control Technology



- 3LCD
- Laser light source



- Force sensors
- Gyro-sensors

## Create a foundation to achieve the corporate vision by increasing production capacity for key products

- Increased production capacity for inkjet printers, projectors, and robots



New PrecisionCore print chip factory at the Hirooka Plant



Additional new factories in the Philippines and Indonesia



Robot production line installed at the Toyoshina Plant

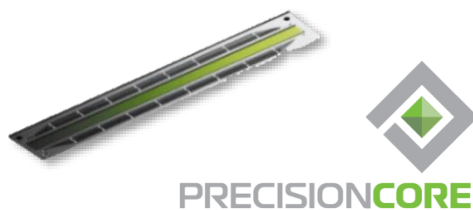

## Improve B2B sales organizations and revamp sales functions

### Strengthening sales functions

#### ■ Strengthened B2B sales organizations in Japan & Europe

- Did not finish the global switch to B2B sales methods that emphasize customer intimacy and solution selling

### Preparations for shift over to B2B

- **Introduced flat-rate plans**  
Japan, Western Europe, etc.

- **Set up solution centers**  
Japan, Germany, France, Spain, U.S., Asia

- **Set up sales sites**  
Vietnam sales affiliate and offices in Bangladesh, Sri Lanka, Munich, Berlin, Madrid and Lisbon

#### *エプソンのスマートチャージ* Unlimited Printing Card

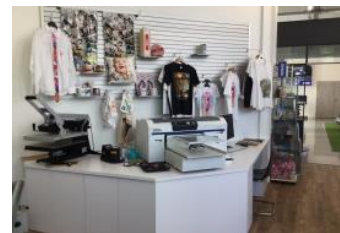

Showroom in Europe



Hirooka solution center



## Achieving sustainability in a circular economy

### Contributing to environment through products and services

- Launched environmentally considerate products



Winner at 1<sup>st</sup> EcoPro Awards\*



Dry process office papermaking system that produces paper on-site



High-speed linehead inkjet multifunction printers that offer both printing performance and low power consumption



High-capacity ink tank printers that save resources through reduced consumables consumption

### Commitment to the SDGs

- Selected 13 goals by mapping Epson 25 and CSR initiatives to SDGs 17 goals

Epson aims to achieve 13 SDGs (as of 3/2018)



\*Minister's prize, the Ministry of Economy, Trade and Industry

1. Goals of Epson 25 Corporate Vision
2. Epson 25 Phase 1 Mid-Range Business Plan Review
- 3. Epson 25 Phase 2 Mid-Range Business Plan**
4. Financial Targets
5. Shareholder Returns



# Direction of Phase 2 based on Phase 1 Review

Issues and changes in environment  
recognized in Phase 1

Cause

Strategic Direction

## Issues

**Responding to rapid  
digitization**

**Creating new markets**

**On-time product launches**

**Establishing B2B  
solution selling**

**Determining investment and  
expenditure priorities**

## Changes in environment

**Greater expectations for  
corporate sustainability actions**

**Increased uncertainty**

**Limit to what Epson  
can do by itself  
simultaneously**

**Lack of B2B  
experience and  
expertise**

**Lack of  
adequate control**

**When operating  
by itself, focus on  
segments where  
Epson can capitalize  
on strengths**

**Collaboration  
Open innovation**

**Strengthen  
B2B sales**

**Strengthen  
control functions**

**Expansion of inkjet  
products and services  
with outstanding  
environmental  
performance**

**Continue to commit to the goals of Epson 25, and transform business operations to achieve high profitability by managing priorities in responding to social issues and environmental changes**

**Accelerate growth by taking maximum advantage of assets and through collaboration and open innovation**

- Strengthen solution selling business
- Rapidly strengthen product lineups, including through collaboration
- Strengthen external sales of core devices and open innovation
- Invest management resources in robotics to accelerate its growth into a core business

.....  
**Strengthen global sales company functions under Head Office control**

- Select and focus on priority business areas and regions
- Improve the organization and allocate personnel to strengthen B2B solution selling
- Strengthen company-wide integrated IT infrastructure

.....  
**Invest management resources in a disciplined manner according to the economic environment and strategy effectiveness**

- Rebuild product portfolios based on priorities
- Strengthen financial discipline

## Steady revenue growth

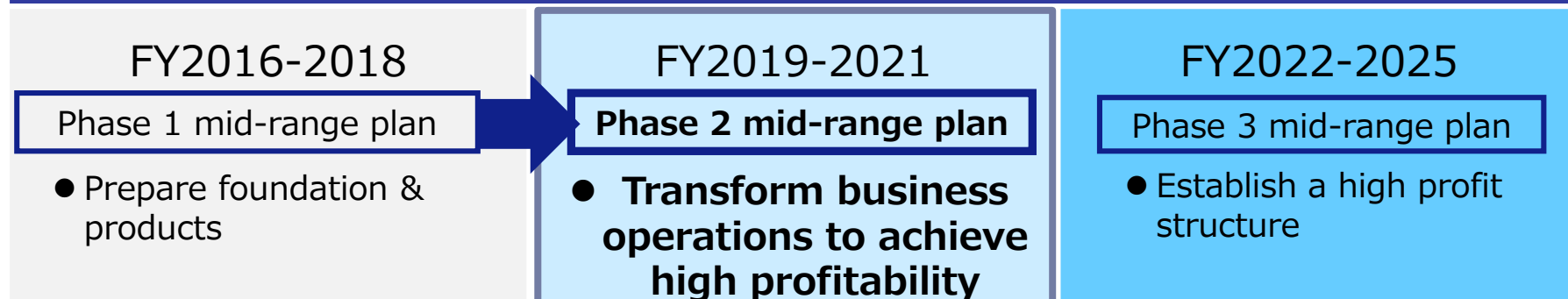

	2018 Outlook
<b>Revenue</b>	¥1,070 billion
<b>Business profit</b>	¥65 billion
<b>ROS</b>	6.1%
<b>ROE</b>	9.5%
<b>Exchange Rate (JPY) USD/EUR/Other*</b>	¥110/¥127/92

	2021 Target
	¥1,200 billion
	¥96 billion
	8%
	Sustain over 10%
	¥110/¥125/92

	2025 Target
	¥1,700 billion
	¥200 billion
	12%
	15%
	¥115/¥125/100

\*Index showing weighted average variance of rates for currencies other than USD and EUR against a benchmark of 100 in 2025



## Inkjet Innovation

- Use inkjets to accelerate office market development, and shift away from the consumables-dependent business model
- Use inkjets to accelerate the digitization of commercial and industrial printing



## Visual Innovation

- Use laser projectors to expand the value of projectors
- Develop new markets



## Wearable Innovation

- Focus on the analog watch segment where Epson can capitalize on its strengths



## Robotics Innovation

- Further accelerate growth and strengthen infrastructure to make robotics a core business

## High-capacity Ink Tank/ Home & SOHO/ Office Shared Printers

### Shift to new business model

- **Use high-capacity ink tank printers to accelerate office market penetration and shift away from the consumables-dependent business model**
  - Replace laser printers and ink cartridge printers with high-capacity ink models (ink pack and ink tank printers)
- **Advertise the advantages of inkjets (environmental performance, low cost) to raise awareness**
- **Strengthen B2B sales capabilities**
- **Continue taking actions to maintain ink cartridge printer prices**

## High-capacity Ink Tank Printers

- **Strengthen the lineup of high-capacity ink tank printers for the office**
  - Strengthen the lineup and launch products that have features that match office printing needs
  - Develop cost-saving designs to support competitiveness
- **Provide services that encourage installation**
  - Roll-out subscription-based services globally

Cartridge-type printers



LP



IJP

High-capacity ink tank printers





## Office Shared Printers

- **Strengthen the lineup of high-speed linehead inkjet multifunction printers**
  - Strengthen the product lineup to meet office demand
  - Provide a comprehensive lineup for the office with a combination of high-capacity ink pack and ink tank printers.
- **Focus on providing solutions in areas where we can take advantage of our strengths**
  - Provide solutions that increase the efficiency of work in different types of businesses



## Commercial and Industrial Printers

### Leading the acceleration of digitization

- 1** Rapidly expand the lineup of high productivity products through platforming and collaboration with partners



- 
- 2** Expand business by responding to a diverse range of needs with external printhead sales and open innovation



PRECISIONCORE

## Commercial and Industrial Printers

### 1 Rapidly expand the lineup of high productivity products through platforming and collaboration with partners

- Maintain high image and product quality, and utilize technology assets for platforming and collaboration
- At the same time, propose software and solutions that are centered around Color Control Technology to capture replacement, expansion, and distributed printing demands

Image &  
Product  
quality  
(high)

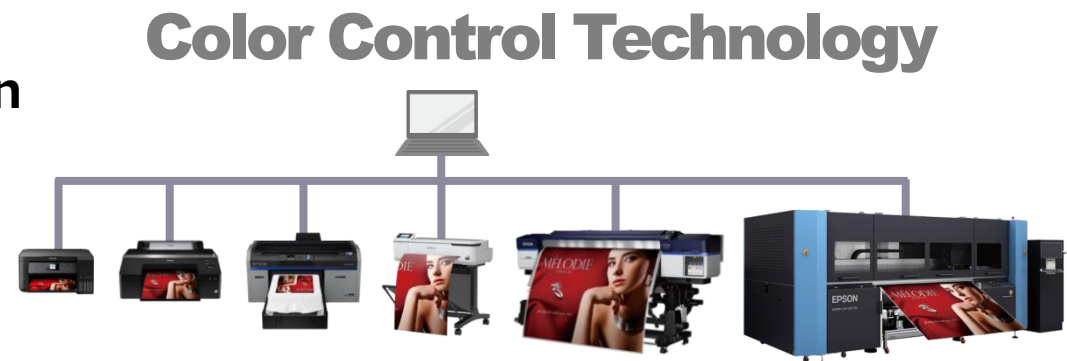
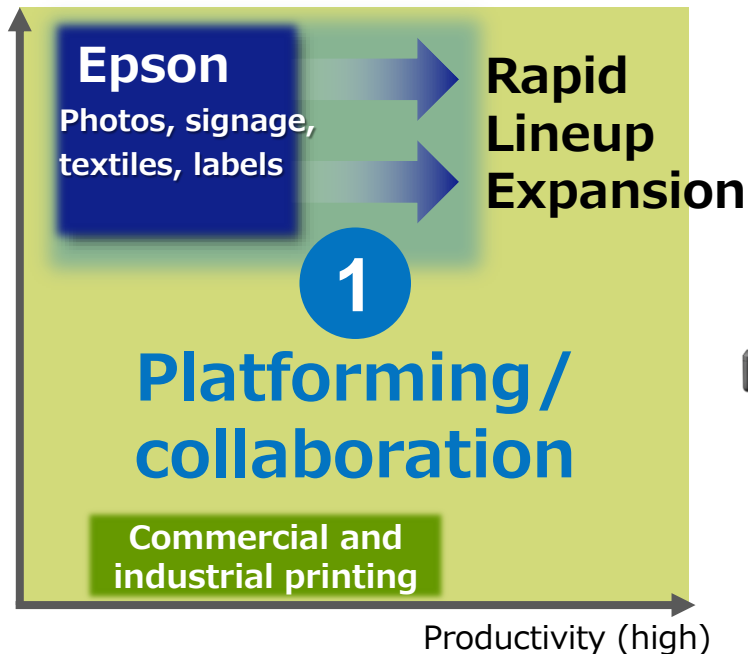

## Commercial and Industrial Printers

### 2 Expand business by responding to a diverse range of needs with external printhead sales and open innovation

- Accelerate digitization by providing printheads for a wide range of applications
- Drive the creation of new markets via open innovation

#### External printhead sales

2

#### Open innovation

Image&Product  
quality (high)

**Epson**

Photos, signage,  
textiles, labels

Photos  
Signage  
Textiles  
Labels



**Inkjet  
Application  
Evolution**

External printhead  
sales/  
Collaboration

Building materials  
Tiles  
Decorations  
Food products  
Cardboard

Commercial and  
industrial printing

Productivity (high)

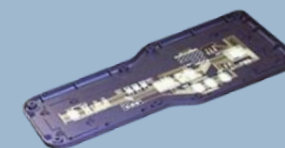

Wiring and PCBs  
Sensor functions  
Color filters  
3D printers

**Electronics**

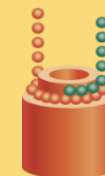

Bio-printing  
  
Cellular  
engineering

**Bio**

## Creating new printing services

Response to rapid digitization (changes in customer touch points)

- Create new printing services through collaboration and open innovation

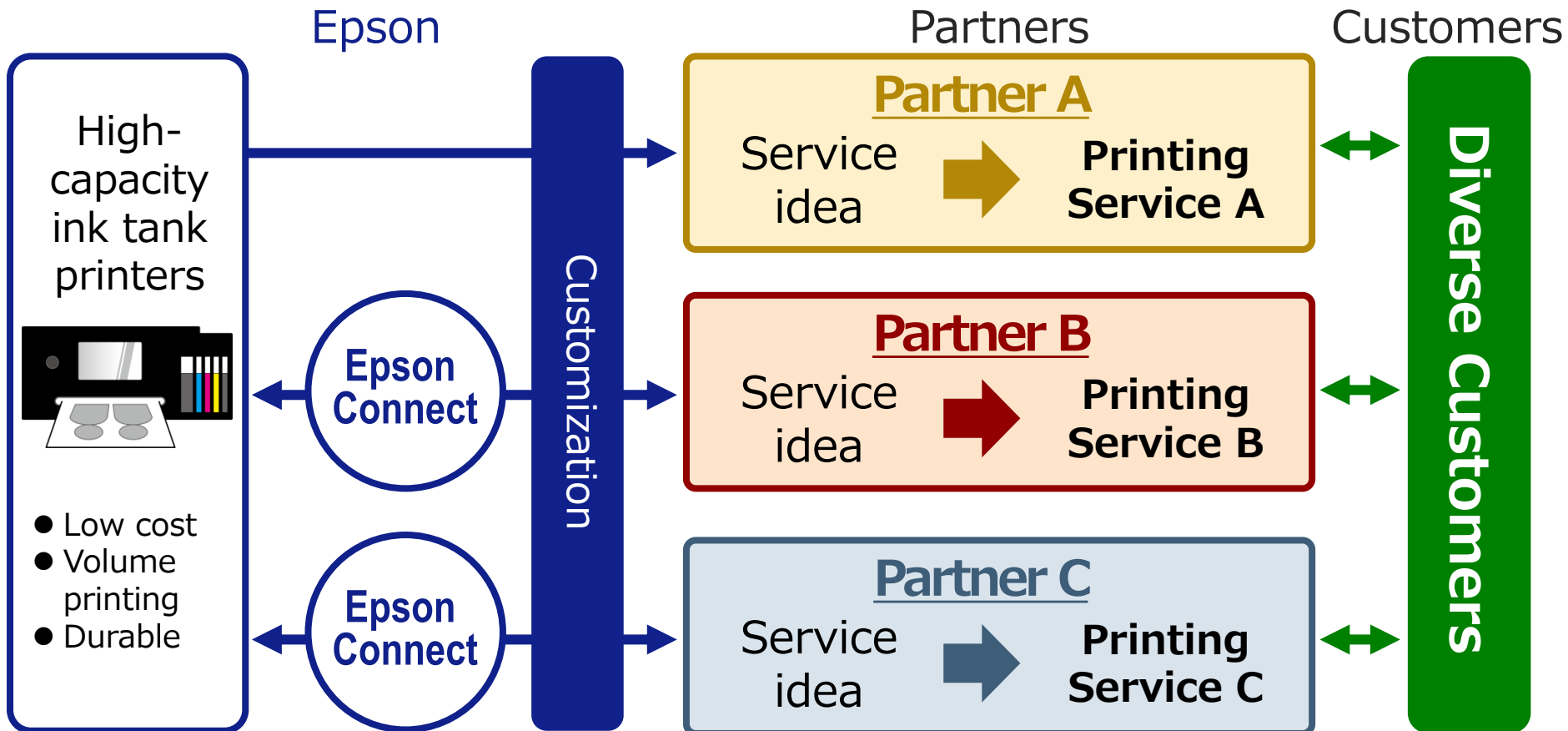

## Projectors

### Increase value and develop new markets

- **Efficiently broaden lineup with laser light source and through platforming to increase market presence and develop new markets**
  - Compete against FPDs and accelerate growth in the high-brightness segment by driving further advances in laser light source engine platforms
  - Create demand in the spatial design market with accent lighting projectors
  - Expand and upgrade the ultra-short throw home projector lineup, and develop small projectors

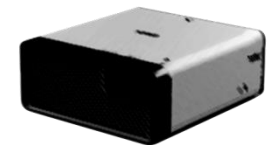
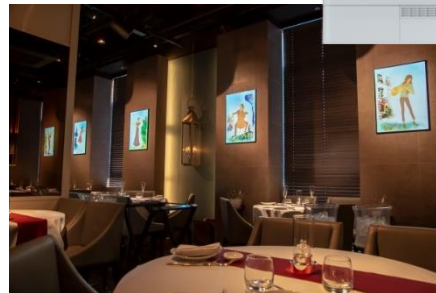

Small projector  
(Conceptual Image)



Home ultra-short  
throw

## Smart Glasses

**New market creation and the provision of functions and services based on customer needs**

- Expand applications through external sales of optical engines and specialized apps
- Offer software for major applications
- Increase offered value through advances in OLED and optics



Remote support



Consumer drones



Industrial drones

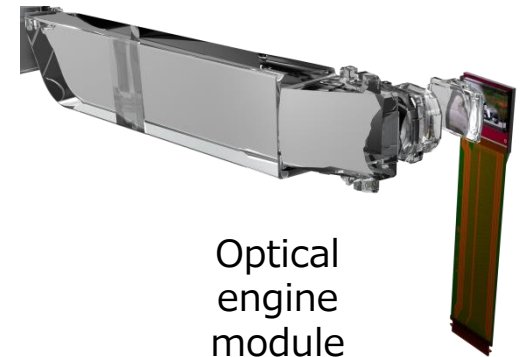

Optical engine module



## Watches

Focus on areas where Epson can capitalize on strengths

- Continue to focus resources on the high-value-added analog watch segment to capitalize on Epson's unique technologies

Epson original brands



TRUME

  
ORIENT STAR

Movement



Seiko Business



(Sold by Seiko Watch Corp.)



## Robotics

**Further accelerate growth and strengthen infrastructure to make robotics a core business**

- Accelerate growth through active collaboration based on Epson technologies (sensors, etc.)
- Use AI to further improve usability
- Enter the collaborative robot market

AI



Force sensor



Vision sensor

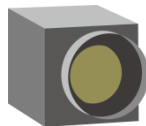

**+ Collaboration**



**Collaborative robots**

(conceptual image)

## Robotics

- Capitalize on Epson's manufacturing knowledge to sell solutions that meet customers' automation requirements

Before



After



Printhead assembly automation

- Further strengthen our sales support system in collaboration with global manufacturing sites

## Strengthening B2B sales capabilities

### Strengthening global sales strategy and control functions

#### ■ Strengthen Head Office control

- Develop a product lineup based on circumstances in each region
- Control sales expenditures based on identified priorities

### Actions to shift to B2B

#### ■ Reinforce functions in Japan and West Europe, which are leading the move to B2B, and share that knowledge globally

- Expand solutions sales
- Roll-out subscription-based services globally
- Develop North American B2B sales channels

#### ■ Strengthen sales human resources and sites

- Increase strength with experienced personnel and sales engineers
- Increase sales offices in the Middle East, Africa, etc.
- Open solutions centers in the central and eastern parts of North America

**Invest management resources in a disciplined manner according to the economic environment and strategy effectiveness**

## **Visualization of business operations and strengthen head office leadership**

- Set up accurate and timely methods to capture situational changes in the field
- Create priorities in product portfolio on a company-wide perspective

## **Renovate business process having “discipline and freedom”**

- Renovate business processes and strengthen company-wide integrated IT infrastructure

## **Strengthen control over investment and expenditure priorities**

- Continue with investments necessary for future growth
- Control expenditure according to strategy effectiveness
  - Carefully review and screen capex with mid-term target as the upper limit
  - Control expenditure priorities on a company-wide perspective holding a balance between revenue growth and increase in SGA.

## Take heightened expectations for achieving sustainability as a business opportunity

Innovation using  
inkjet technology

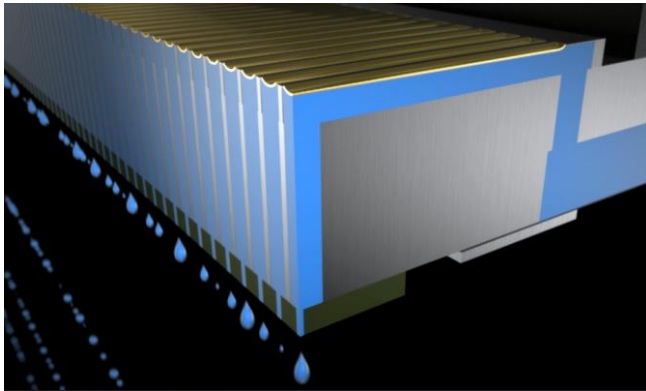

Epson aims to achieve 13 SDGs  
(as of 3/2018)



**Inkjet**

**=**

**Helping to develop  
a sustainable society**

# Phase 2 Targets (breakdown)

## Revenue

Billion JPY

1,200

1,070

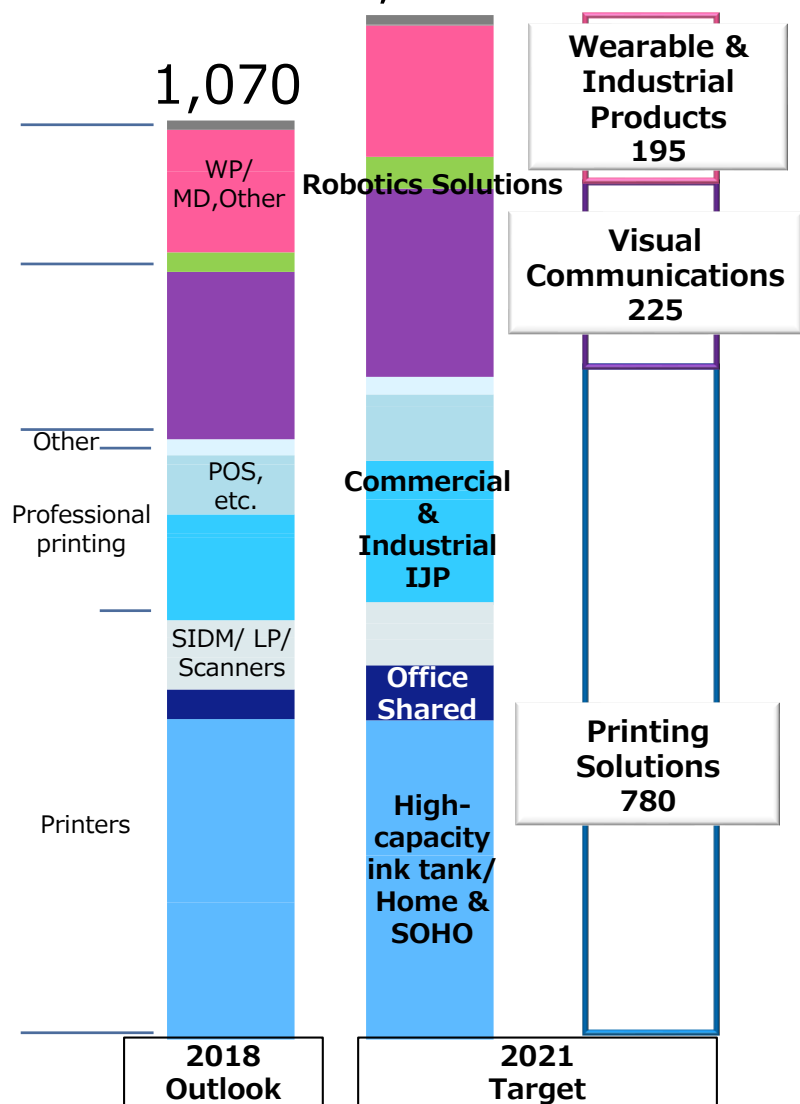

## Business profit

	2018 Outlook	2021 Target
Business Profit	65 billion	96 billion
ROS	6.1%	8%

## Product category targets

		2018 Outlook	2021 Target
High-capacity ink tank	Volume	9.2 million	12.5 million
Home & SOHO	Volume	6.2 million	4.4 million
Office Shared	Revenue	Mid-single digit% of segment	Around 10% of segment
Commercial & Industrial IJP	Revenue	High-teen% of segment	Around 20% of segment
Projectors	Volume	2.6 million	2.9 million
Robotics Solutions	Revenue	23 billion	Around 20% of segment

1. Goals of Epson 25 Corporate Vision
2. Epson 25 Phase 1 Mid-Range Business Plan Review
3. Epson 25 Phase 2 Mid-Range Business Plan
- 4. Financial Targets**
5. Shareholder Returns



# Cash Flow (CF) & Capital Expenditure Plans

- Restore our ability to generate cash flow by steadily growing profit and increasing operations efficiency
- Prioritize and allocate generated cash to growth areas
- Payout steady dividends while maintaining a healthy financial structure

Item	Phase 1 Mid-range outlook*	Phase 2 Mid-range target
Operating CF	3 year total: ¥274.1 billion	3 year total: ¥370 billion
FCF	3 year total: ¥44.7 billion	3 year total: ¥170 billion

R&D Expense	3 year total: ¥158 billion	Aggressively invest in new products and key technologies necessary to achieve Epson 25
Capital Expenditure (excluding lease)	3 year total: ¥237.7 billion	3 year total: ¥200 billion (Production capability, new products)

\*FY2016 & FY2017: Actual, FY2018: Outlook



- Steadily grow revenue and profit during Phase 2 to secure stable operating cash flows and prioritize investment in growth to achieve Epson 25, while also maintaining a robust financial structure and securing capital efficiency to sustain ROE of over 10%

- Strike a balance with revenue growth & control expenses from a company-wide perspective (aggressively spend in growth areas and increase efficiency in existing areas)
- In addition to rigorous selection by setting a hurdle rate, do test risk scenarios and strengthen company-wide discipline and control over capital expenditure by Head Office



- Maintain a robust financial structure that can withstand sudden changes in the business environment and intense competition
- Optimize capital efficiency (proactive profit sharing and agile share repurchase)

1. Goals of Epson 25 Corporate Vision
2. Epson 25 Phase 1 Mid-Range Business Plan Review
3. Epson 25 Phase 2 Mid-Range Business Plan
4. Financial Targets
5. **Shareholder Returns**



- Provide continuous and stable shareholder returns

Category	Phase 1 Mid-range plan	Phase 2 Mid-range Plan
Dividends: consolidated dividend payout ratio*	FY2018: Outlook Approx. 48%	Approx. 40%
Share Repurchase	FY2016: Repurchased ¥10 billion	Agilely purchase shares as warranted by share price, the capital situation, and other factors

\*Calculated based on profit after an amount equivalent to the statutory effective tax rate is deducted from business profit, which shows profit from operations



# Exceed Your Vision

**Epson moves you in a powerful way.  
And we do this through our commitment to  
developing technology that inspires and  
empowers people all over the world.**

# Reference



# Definition of term

<b>Color Control Technology</b>	Color managing technology that enhances color reproducibility
<b>Epson Connect</b>	Epson's mobile cloud service for Epson products and services
<b>I/C</b>	Ink cartridges
<b>IJP</b>	Inkjet printers
<b>LIJ</b>	Line inkjet printers, high-speed line inkjet multifunction printers
<b>LP</b>	Laser printers, including multi function printers
<b>POS</b>	Point of sales, POS printers : small receipt printers
<b>RIPS</b>	Replaceable ink pack system, high-yield cartridge-free ink pack printers
<b>SOHO</b>	Small office, home office
<b>Office Shared Printers</b>	One of printer category for high print volume office users. This includes LIJ, RIPS, and I/C printers.
<b>Photos</b>	Printer product category that includes large format printers for photo, graphics, proofing and CAD printing
<b>High-capacity ink tank printers</b>	Inkjet printers with high-capacity ink tank (includes EcoTank)
<b>High-capacity ink models</b>	General term for high-capacity ink cartridge printers, high-capacity ink tank printers, RIPS, and LIJ
<b>Distributed printing</b>	Printing method that prints out same images/documents by using several printers
<b>3LCD</b>	Technology that projects images by utilizing 3LCD-chips
<b>FPD</b>	Flat panel displays
<b>OLED</b>	Organic light emitting diode
<b>High-brightness laser projectors</b>	High lumen projectors mainly used in venues such as conference rooms and halls
<b>WP</b>	Wearable Products business
<b>MD, Other</b>	Microdevices, Other business
<b>ROS</b>	Business profit/ revenue
<b>ROE</b>	Profit for the year attributable to owners of the parent company/ Equity attributable to owners of the parent company (avg. balance)

# Printer market size (IJP+LP | Monetary basis)

## Printer main unit + consumables (Worldwide)

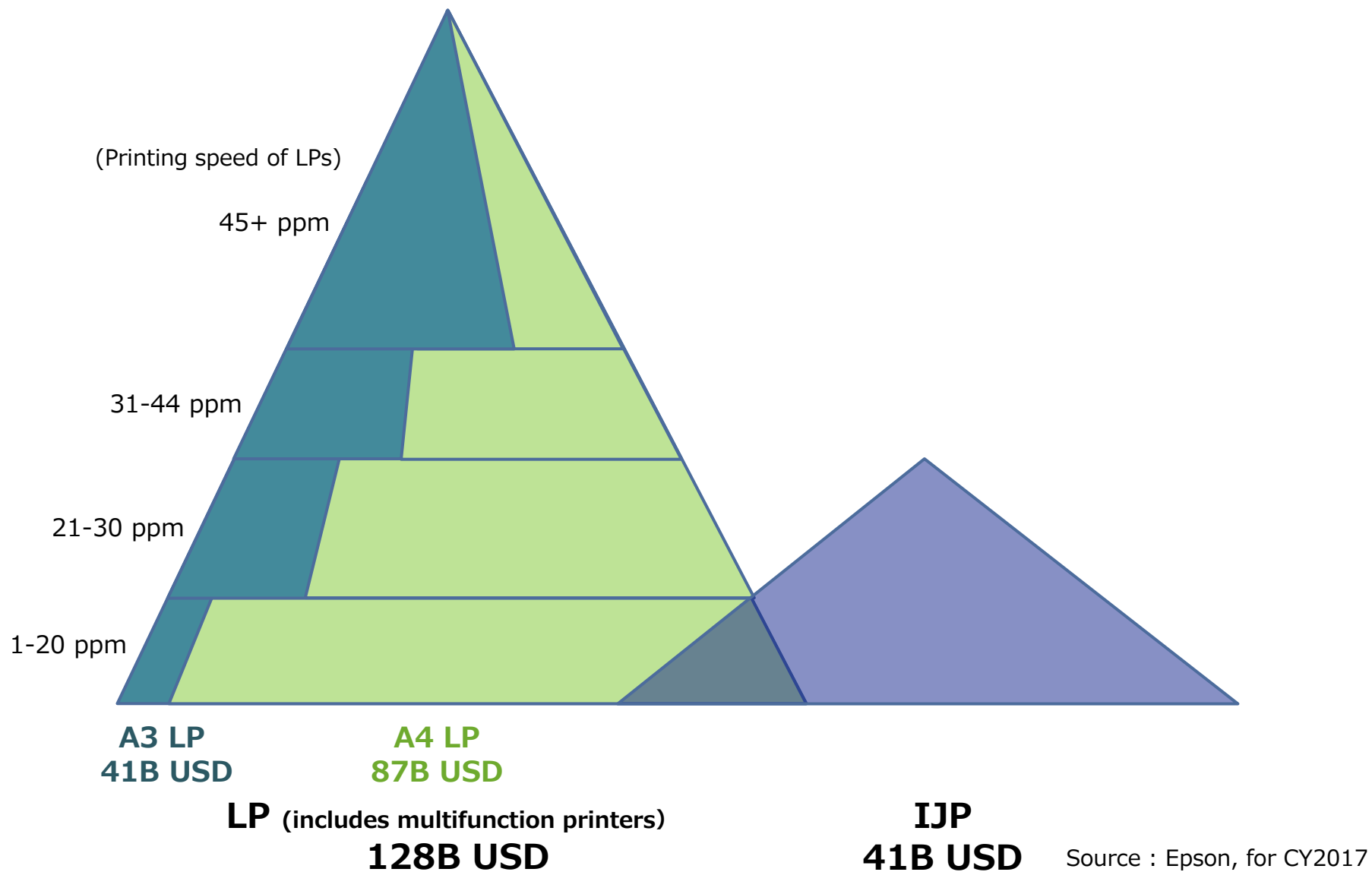

# Printer market size (IJP+LP | Unit Volume)

## Printer main unit market trend (Worldwide)

(Thousand units)

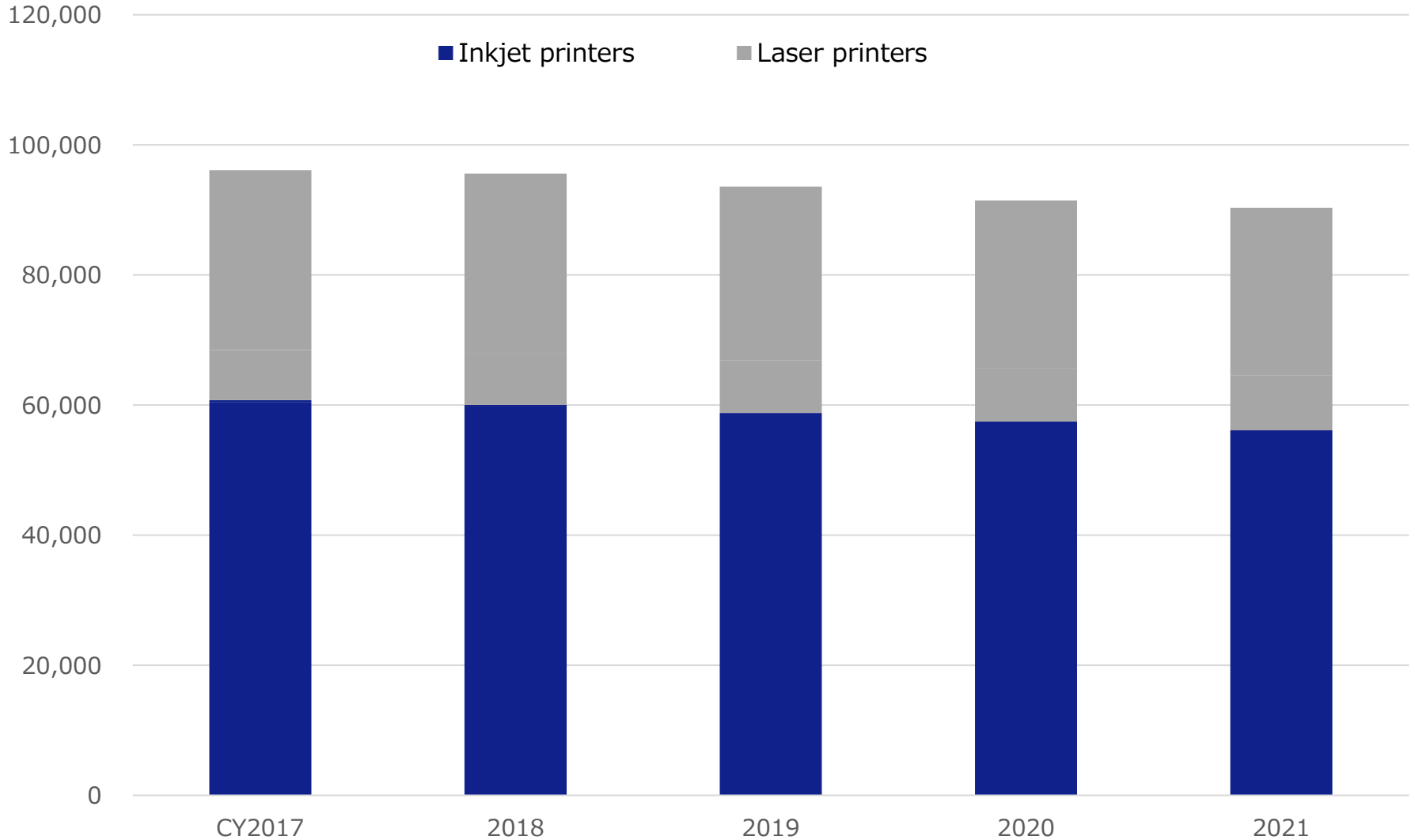



# Penetration of High-Capacity Ink Tank Printers (Unit Volume)

## A4 printer main unit market trend by region

### Latin America

### Asia-Pacific

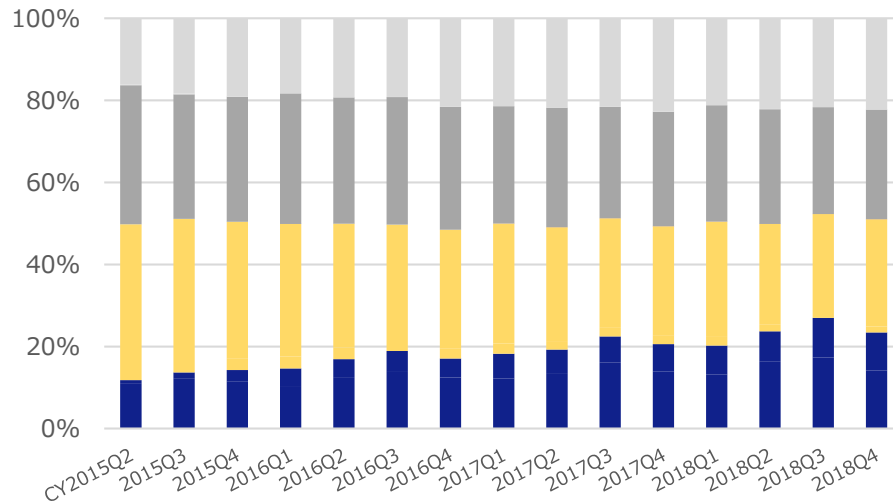
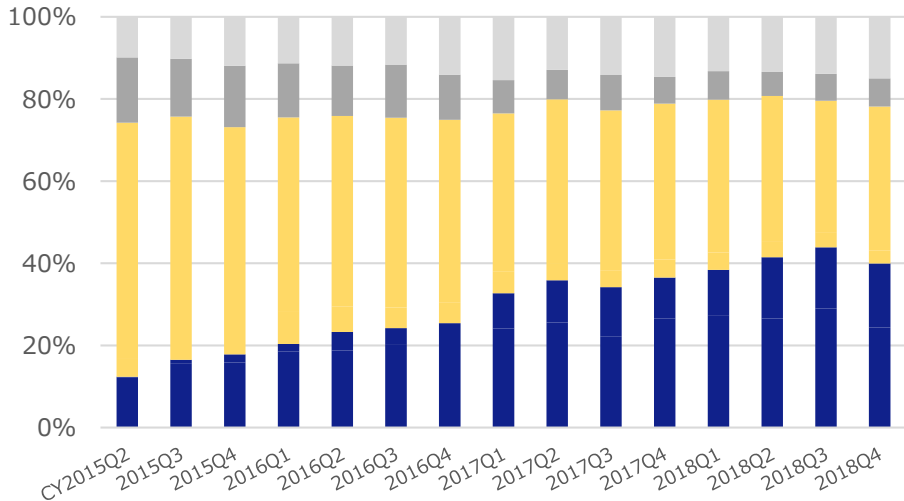

### Developed markets (Japan, US, Western Europe, Canada)

### Eastern Europe, Middle East, and Africa

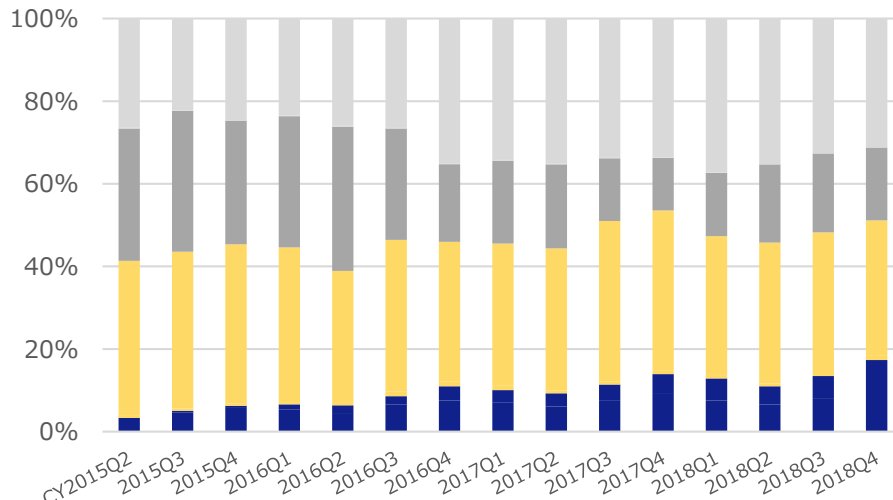
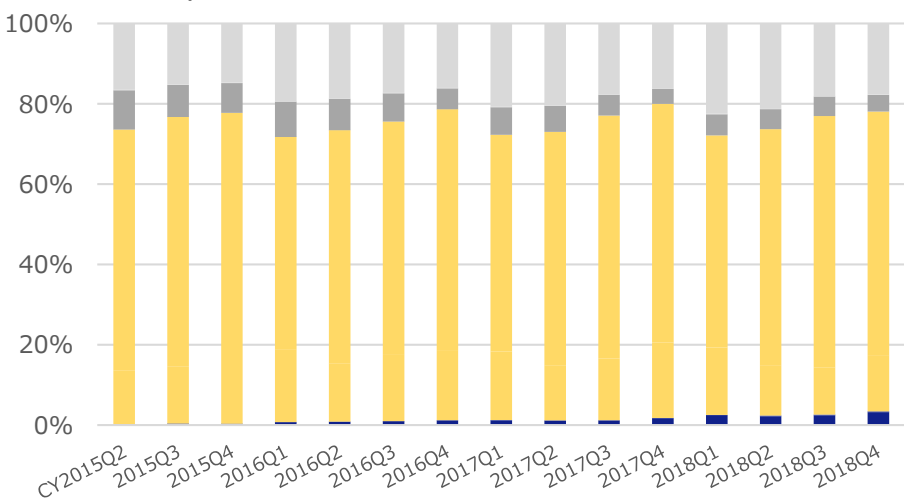

■ Ink tank printers      ■ Ink cartridge printers  
■ Laser printers (1-20 ppm)      ■ Laser printers (21 ppm and more)

IDC Worldwide Quarterly Hardcopy Peripherals Tracker 2018Q4  
 Printers include multifunction printers. Reproduction or republication of this data is prohibited.

# Commercial and Industrial Printing Market Size (Photo/Signage/Textiles/Labels | Monetary Value)

FY17 Market size by category  
(Printer main unit + consumables)

**Worldwide 33B USD**

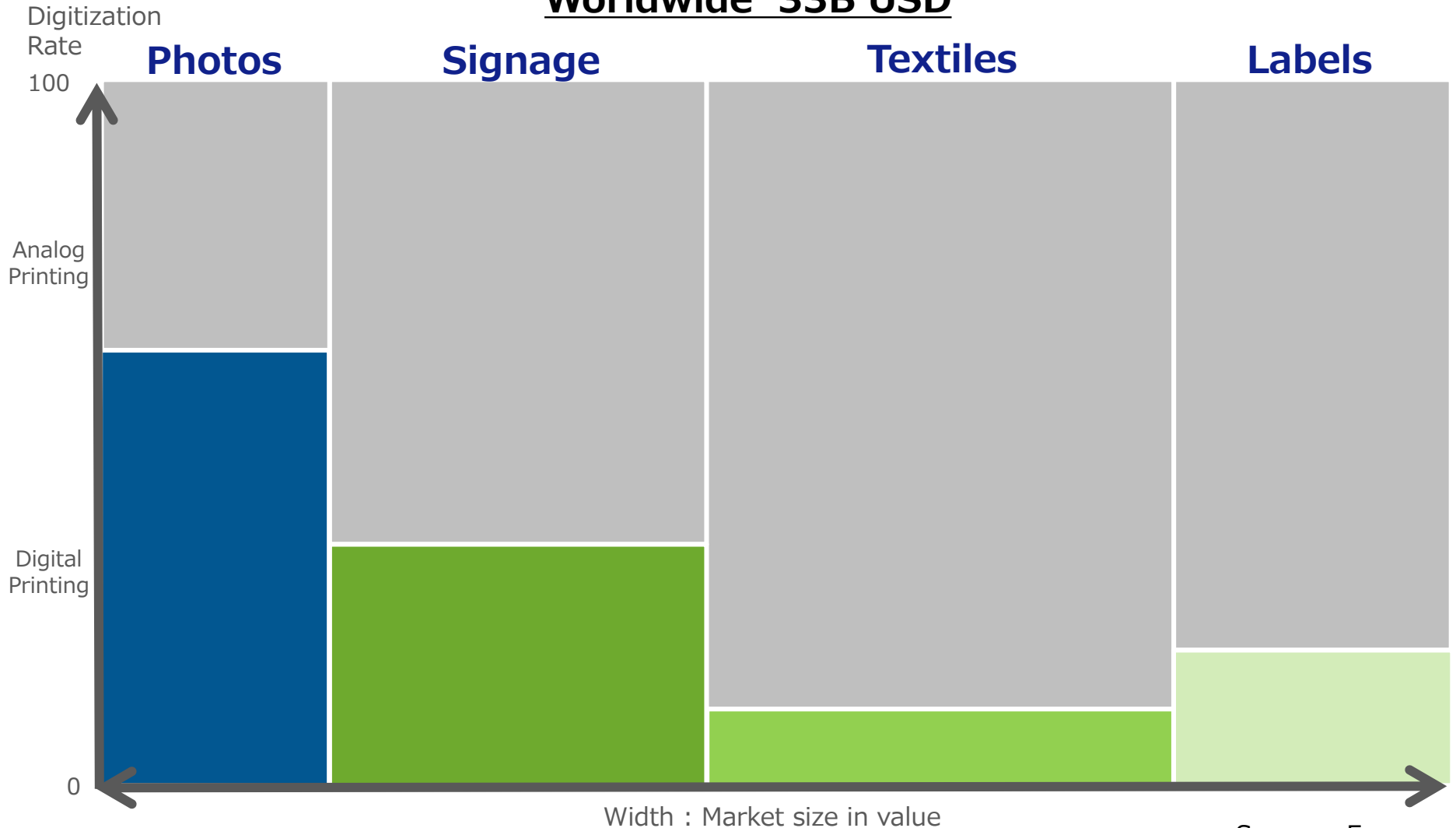

Source : Epson

# Commercial and Industrial Printing Market Size (Photo/Signage/Textiles/Labels | Unit volume)

## Digital printing market size trend by category (Worldwide)

(Thousand units)



Source : Epson

# Projector market size (Unit volume)

## Projector market trend (Worldwide)

(Thousand units)

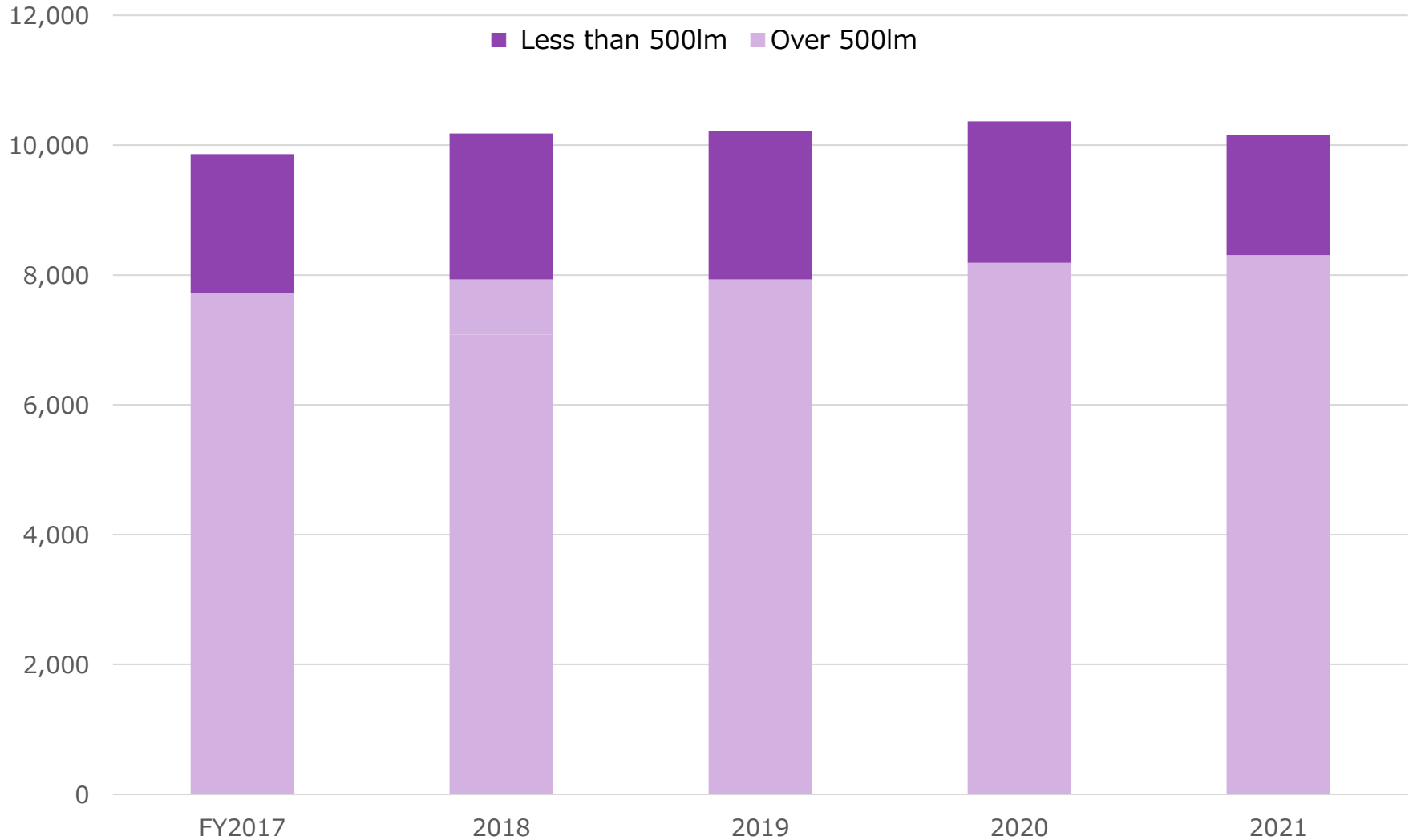

Source : Epson

# Robot market size (Monetary Basis)

## Compact precision robot maker trend

(Billion yen)

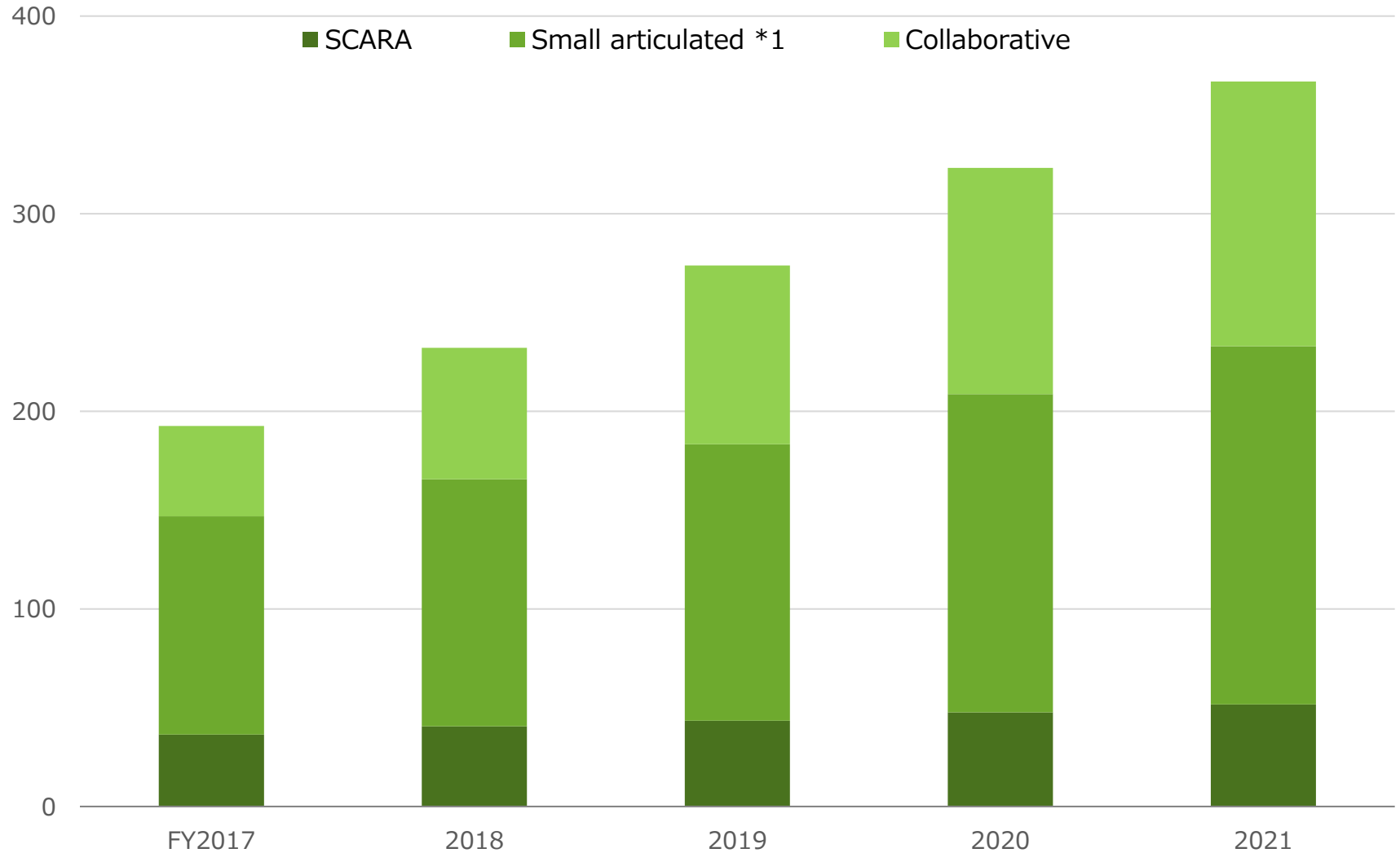

\*1 Vertically articulated robots with a max. payload of 20kg

Source : Epson

**EPSON**

**EXCEED YOUR VISION**